

NOV  
2011  
UPDATE  
NEW DOORS  
NEW 4 CROWN  
SPECIFICATION

# GARAGE DOOR

PRICE LIST MAY 2011



## GRP GARAGE DOORS

Wessex GRP Products is Europe's largest manufacturer of low maintenance G.R.P. (Glass Reinforced Polyester) garage doors and a leading innovator in the field of garage door design.

Based in Verwood, Dorset, with its head office at Blackrod, Bolton, Wessex GRP Products manufactures a range of hand built and finished doors in strong durable G.R.P. with either luxury Gloss White or faithfully reproduced Woodgrain finishes..

Welcome to the Wessex Garage Doors Price List

G.R.P. is an incredibly strong, dent resistant modern composite laminate with a better strength to weight ratio than steel. The door face is devoid of joints, seams, rivets or fastenings to detract from its good looks. All doors are supplied fully finished, won't warp, shrink or rust and are virtually maintenance free.

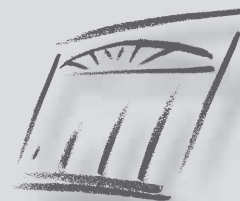

**wessex**  
DOORS







### Contents:

G.R.P. SECTIONAL Garage Doors	3
G.R.P. UP AND OVER GARAGE DOORS	4 - 8
UP & OVER DOOR OPTIONS	9
AUTOMATION	9
G.R.P. SIDE HINGED GARAGE DOORS	10 - 11
TECHNICAL DETAILS	12 - 15
Warranty	16

### PRICES & NOTES

All Prices are in £ Sterling and exclude VAT & delivery  
Illustrations in this brochure are intended as a guide only to product styles and profiles. Handle positions will vary dependent upon the style, operation and size of the door. Side and top stiles (the area around a particular design) may vary in width and height dependent upon the size, even on doors of the same style.

### Key to symbols

Standard Sizes only	
Made to Measure available	
Security Multi-Point Locking	
Luxury 5 Crown G.R.P. Doors available	
Glazing Options available – see page 9 for pricing	
Frames available – see page 9 for pricing	
Doors available over 2134mm (7'0") high	

### DELIVERY CHARGES

All doors  
Delivery charges any quantity of door: **£55.00 NET**  
Mainland England, Scotland and Wales only. Northern Ireland, Channel Islands, Isle of Man, and export delivery – charges on application. Delivery charges and VAT to be added to all prices.



# SECTIONAL GARAGE DOORS

KEY: Standard doors double skin DC: Includes automation 40: Foam filled insulation

WIDTH	VIENNA		VIENNA DC		VIENNA 40		VIENNA 40 DC	
	Height 6'6" - 7'0" 1981 - 2134(mm)	Height >7'0" to 7'6" 2134 to 2286(mm)	Height 6'6" - 7'0" 1981 - 2134(mm)	Height >7'0" to 7'6" 2134 to 2286(mm)	Height 6'6" - 7'0" 1981 - 2134(mm)	Height >7'0" to 7'6" 2134 to 2286(mm)	Height 6'6" - 7'0" 1981 - 2134(mm)	Height >7'0" to 7'6" 2134 to 2286(mm)
2134mm (7'0")	1980	2145	2308	2473	2433	2598	2761	2927
2438mm (8'0")	2028	2196	2357	2525	2491	2661	2820	2989
2743mm (9'0")	2092	2253	2421	2581	2533	2695	2862	3023
3048mm (10'0")	2413	2574	2742	2902	3298	3459	3627	3787
3353mm (11'0")	2574	2735	2978	3140	3459	3620	3863	4025
3658mm (12'0")	2735	2896	3140	3300	3620	3781	4025	4185
3962mm (13'0")	2896	3056	3300	3461	3781	3942	4185	4347
4267mm (14'0")	2710	2868	3114	3273	3586	3743	3991	4148
4572mm (15'0")	3217	3377	3621	3782	4102	4263	4506	4668
4877mm (16'0")	3377	3538	3782	3942	4263	4422	4668	4826

MtoM widths: 6'10" to 16'0" MtoM heights: 6'6" to 7'6"  
MtoM widths (mm): 2083 to 4877 MtoM heights (mm): 1981 to 2286

WIDTH	VIENNA • OSLO VERONA		VIENNA • OSLO VERONA DC		VIENNA • OSLO VERONA 40		VIENNA • OSLO VERONA 40 DC	
	Height 6'6" - 7'0" 1981 - 2134(mm)	Height >7'0" to 7'6" 2134 to 2286(mm)	Height 6'6" - 7'0" 1981 - 2134(mm)	Height >7'0" to 7'6" 2134 to 2286(mm)	Height 6'6" - 7'0" 1981 - 2134(mm)	Height >7'0" to 7'6" 2134 to 2286(mm)	Height 6'6" - 7'0" 1981 - 2134(mm)	Height >7'0" to 7'6" 2134 to 2286(mm)
2134mm (7'0")	2145	2310	2473	2638	2598	2761	2927	3090
2438mm (8'0")	2196	2366	2525	2695	2661	2830	2989	3158
2743mm (9'0")	2253	2413	2581	2742	2695	2854	3023	3183
3048mm (10'0")	2574	2735	2902	3064	3459	3620	3787	3949
3353mm (11'0")	2735	2896	3140	3300	3620	3781	4025	4185
3658mm (12'0")	2896	3056	3300	3461	3781	3942	4185	4347
3962mm (13'0")	3056	3217	3461	3621	3942	4102	4347	4506
4267mm (14'0")	2877	3035	3281	3439	3754	3910	4159	4315
4572mm (15'0")	3377	3538	3782	3942	4263	4422	4668	4826
4877mm (16'0")	3538	3701	3942	4105	4422	4583	4826	4988

MtoM widths: 6'10" to 16'0" MtoM heights: 6'6" to 7'6"  
MtoM widths (mm): 2083 to 4877 MtoM heights (mm): 1981 to 2286

OPTIONS	
Manual locking	48
Black windows for Vienna single doors up to 2438mm (8'0") wide (please specify leading requirements)	160
Black windows for Vienna double doors over 2438mm (8'0") wide (please specify leading requirements)	320
Porthole Windows (Per window) Oslo only (please specify location) (330mm overall diameter, 250mm glazed diameter)	320
Colour Option available for Woodgrain doors only - blue, green and red - for single doors up to 2438mm (8'0") wide	300
Colour Option available for Woodgrain doors only - blue, green and red - for double doors over 2438mm (8'0") wide	395

DC OPTIONS	
Upgrade to DC850 from DC700 (for single sectionals up to 3048mm (10'))	68
Beam break	70
Beam break bracket	14
Wireless bell push	40
Wired bell push	12
Electric key switch control	41
Exterior digital keyless entry pad	93
Emergency release (handle type)	31
External receiver	102
Car cigarette lighter transmitter (3 channel)	58
Mini transmitter (4 channel)	49
Three function wired wall control	37
Impulse socket receiver	72
Chain Drive (standard)	0
Kevlar Belt drive	48
Two piece extended chain drive boom	21
Two piece extended Kevlar belt drive boom	74



# ONE PIECE UP & OVER GARAGE DOORS

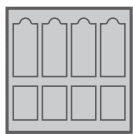

## NEWBURY

WIDTH	NEWBURY				
	CANOPY		RETRACTABLE		
	3	4	3	4	5
1981mm (6'6")	1264	1384	1311	1431	1852
2134mm (7'0")	1264	1384	1311	1431	1852
2261mm (7'5")	1301	1421	1348	1468	1887
2286mm (7'6")	1301	1421	1348	1468	1887
2438mm (8'0")	1351	1471	1398	1518	1983
2743mm (9'0")			1806	2006	2475
3048mm (10'0")			1976	2176	2647
3353mm (11'0")			2205	2405	
3658mm (12'0")			2376	2576	
3962mm (13'0")			2422	2622	
4267mm (14'0")			2447	2647	
4572mm (15'0")			2808	3008	
4877mm (16'0")			3223	3423	

MtoM widths: 6'6" to 16'0"  
MtoM heights: 6'6" to 7'0"

MtoM widths (mm): 1981 to 4877  
MtoM heights (mm): 1981 to 2134



## WIMBORNE

WIDTH	WIMBORNE				
	CANOPY		RETRACTABLE		
	3	4	3	4	5
1981mm (6'6")	1390	1510	1438	1558	1977
2134mm (7'0")	1390	1510	1438	1558	1977
2261mm (7'5")	1528	1648	1576	1696	2115
2286mm (7'6")	1528	1648	1576	1696	2115
2438mm (8'0")	1581	1701	1628	1748	2166
2743mm (9'0")			1929	2129	2598
3048mm (10'0")			2097	2297	2769
3353mm (11'0")			2330	2530	
3658mm (12'0")			2499	2699	
3962mm (13'0")			2537	2737	
4267mm (14'0")			2563	2763	
4572mm (15'0")			2987	3187	
4877mm (16'0")					

MtoM widths: 5'2" to 15'0"  
MtoM heights: 6'2" to 7'0"

MtoM widths (mm): 1575 to 4572  
MtoM heights (mm): 1880 to 2134

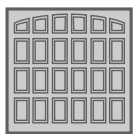

## ASHTON

WIDTH	ASHTON				
	CANOPY		RETRACTABLE		
	3	4	3	4	5
1981mm (6'6")	1362	1482	1409	1529	1947
2134mm (7'0")	1362	1482	1409	1529	1947
2261mm (7'5")	1568	1688	1615	1735	2153
2286mm (7'6")	1568	1688	1615	1735	2153
2438mm (8'0")	1619	1739	1666	1786	2205
2743mm (9'0")			1918	2118	2589
3048mm (10'0")					
3353mm (11'0")					
3658mm (12'0")					
3962mm (13'0")					
4267mm (14'0")					
4572mm (15'0")					
4877mm (16'0")					

MtoM widths: 6'9" to 8'6"  
MtoM heights: 6'5" to 7'6"

MtoM widths (mm): 2057 to 2591  
MtoM heights (mm): 1956 to 2286

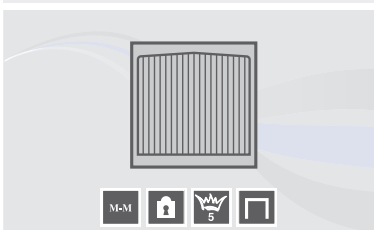

## AVONBROOK

WIDTH	AVONBROOK				
	CANOPY		RETRACTABLE		
	3	4	3	4	5
1981mm (6'6")	1362	1482	1409	1529	1947
2134mm (7'0")	1362	1482	1409	1529	1947
2261mm (7'5")	1568	1688	1615	1735	2153
2286mm (7'6")	1568	1688	1615	1735	2153
2438mm (8'0")	1619	1739	1666	1786	2205
2743mm (9'0")			1918	2118	2589
3048mm (10'0")			2086	2286	2757
3353mm (11'0")			*2287	*2487	
3658mm (12'0")			*2556	*2756	
3962mm (13'0")			2644	2844	
4267mm (14'0")			2670	2870	
4572mm (15'0")			3056	3256	
4877mm (16'0")			*3360	*3560	

MtoM widths: 6'6" to \*10'4"  
& \*11'4" to \*15'6"  
MtoM heights: 6'6" to 7'0"

MtoM widths (mm): 1981 to \*3150  
& \*3454 to \*4724  
MtoM heights (mm): 1981 to 2134

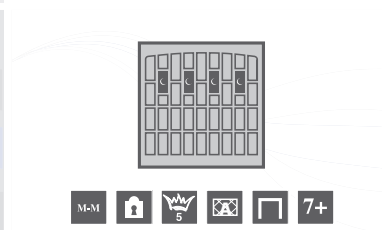

## BLENHEIM

WIDTH	BLENHEIM				
	CANOPY		RETRACTABLE		
	3	4	3	4	5
1981mm (6'6")					
2134mm (7'0")	2033	2153	2081	2201	2620
2261mm (7'5")	2329	2449	2376	2496	2916
2286mm (7'6")	2329	2449	2376	2496	2916
2438mm (8'0")	2382	2502	2429	2549	2969
2743mm (9'0")			2620	2820	3290
3048mm (10'0")			2861	3061	3531
3353mm (11'0")			2999	3199	
3658mm (12'0")					
3962mm (13'0")					
4267mm (14'0")			*3487	*3687	
4572mm (15'0")			3839	4039	
4877mm (16'0")					

MtoM widths: 6'7" to 11'0"  
& \*13'2" to 15'0"  
MtoM heights: 6'6" to 8'0"

MtoM widths (mm): 2007 to 3353  
& \*4013 to 4572  
MtoM heights (mm): 1981 to 2438

# ONE PIECE UP & OVER GARAGE DOORS

6

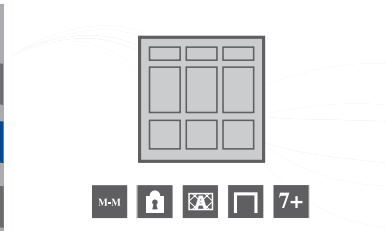

WIDTH	BOSTON				
	CANOPY		RETRACTABLE		
	3	4	3	4	5
1981mm (6'6")			1526	1646	
2134mm (7'0")			1526	1646	
2261mm (7'5")			1734	1854	
2286mm (7'6")			1734	1854	
2438mm (8'0")			1784	1904	
2743mm (9'0")			2016	2216	
3048mm (10'0")					
3353mm (11'0")					
3658mm (12'0")					
3962mm (13'0")					
4267mm (14'0")			2770	2970	
4572mm (15'0")			3156	3356	
4877mm (16'0")			*3460	*3660	

MtoM widths: 6'0" to 9'0" & 14'0" to 15'6"  
MtoM heights: 6'9" to 8'0"  
  
MtoM widths (mm): 1829 to 2743 & 4267 to 4724  
MtoM heights (mm): 2057 to 2438



WIDTH	CANTERBURY (WIDE GRAIN)				
	CANOPY		RETRACTABLE		
	3	4	3	4	5
1981mm (6'6")	1362	1482	1409	1529	1957
2134mm (7'0")	1362	1482	1409	1529	1947
2261mm (7'5")	1568	1688	1615	1735	2153
2286mm (7'6")	1568	1688	1615	1735	2153
2438mm (8'0")	1619	1739	1666	1786	2205
2743mm (9'0")			1918	2118	2589
3048mm (10'0")			2086	2286	2757
3353mm (11'0")			2287	2487	
3658mm (12'0")			2556	2756	
3962mm (13'0")			2644	2844	
4267mm (14'0")			2670	2870	
4572mm (15'0")			3056	3256	
4877mm (16'0")			3360	3560	

MtoM widths: 5'0" to 16'0"  
MtoM heights: 6'3" to 7'0"  
  
MtoM widths (mm): 1524 to 4877  
MtoM heights (mm): 1905 to 2134



\*Black windows only

WIDTH	COMPTON				
	CANOPY		RETRACTABLE		
	3	4	3	4	5
1981mm (6'6")					
2134mm (7'0")	1362	1482	1409	1529	2051
2261mm (7'5")	1568	1688	1615	1735	2256
2286mm (7'6")	1568	1688	1615	1735	2256
2438mm (8'0")	1619	1739	1666	1786	2308
2743mm (9'0")					
3048mm (10'0")					
3353mm (11'0")					
3658mm (12'0")					
3962mm (13'0")					
4267mm (14'0")			*2770	*2970	
4572mm (15'0")			3156	3356	
4877mm (16'0")					

MtoM widths: 6'8" to 8'0" & 13'6" to 15'0"  
MtoM heights: 6'3" to 7'6"  
  
MtoM widths (mm): 2032 to 2438 & 4114 to 4572  
MtoM heights (mm): 1905 to 2286

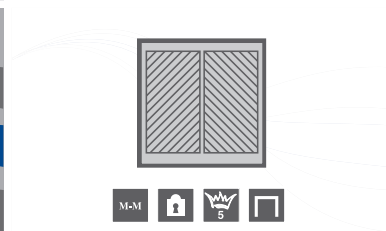

WIDTH	COUNTY				
	CANOPY		RETRACTABLE		
	3	4	3	4	5
1981mm (6'6")					
2134mm (7'0")	1362	1482	1409	1529	
2261mm (7'5")	1568	1688	1615	1735	
2286mm (7'6")	1568	1688	1615	1735	
2438mm (8'0")	1619	1739	1666	1786	
2743mm (9'0")					
3048mm (10'0")					
3353mm (11'0")					
3658mm (12'0")			2556	2756	
3962mm (13'0")			2644	2844	
4267mm (14'0")			2670	2870	
4572mm (15'0")			3056	3256	
4877mm (16'0")			*3360	*3560	

MtoM widths: 6'11" to 8'0" & \*12'3" to 15'3"  
MtoM heights: 6'3" to 7'0"  
  
MtoM widths (mm): 2108 to 2438 & \*3743 to 4648  
MtoM heights (mm): 1905 to 2134



WIDTH	ELSTEAD				
	CANOPY		RETRACTABLE		
	3	4	3	4	5
1981mm (6'6")					
2134mm (7'0")	1362	1482	1409	1529	1947
2261mm (7'5")	1568	1688	1615	1735	2153
2286mm (7'6")	1568	1688	1615	1735	2153
2438mm (8'0")	1619	1739	1666	1786	2205
2743mm (9'0")			*1918	*2118	*2589
3048mm (10'0")					
3353mm (11'0")					
3658mm (12'0")					
3962mm (13'0")					
4267mm (14'0")			*2618	*2818	
4572mm (15'0")			3056	3256	
4877mm (16'0")					

MtoM widths: 6'9" to \*8'4" & \*13'1" to \*15'0"  
MtoM heights: 6'4" to 7'6"  
  
MtoM widths (mm): 2057 to \*2540 & \*3988 to \*4572  
MtoM heights (mm): 1930 to 2286

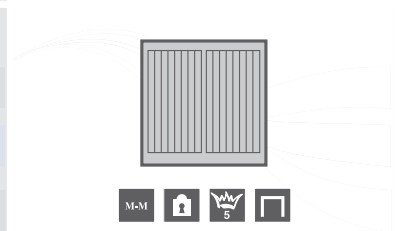

WIDTH	FRENSHAM (WIDE GRAIN)				
	CANOPY		RETRACTABLE		
	3	4	3	4	5
1981mm (6'6")					
2134mm (7'0")	1362	1482	1409	1529	1947
2261mm (7'5")	1568	1688	1615	1735	2153
2286mm (7'6")	1568	1688	1615	1735	2153
2438mm (8'0")	1619	1739	1666	1786	2205
2743mm (9'0")					
3048mm (10'0")					
3353mm (11'0")					
3658mm (12'0")					
3962mm (13'0")					
4267mm (14'0")					
4572mm (15'0")			*2618	*2818	
4877mm (16'0")			3056	3256	
			*3360	*3560	

MtoM widths: 6'8" to 8'0" & \*13'9 1/2" to \*15'3"  
MtoM heights: 6'0" to 6'6" & 6'7" to 7'0" (up to 8'0" wide) & 6'4" to 7'0" (from 13'9 1/2" to 15'3")  
  
MtoM widths (mm): 2032 to 2438 & \*4204 to \*4648  
MtoM heights (mm): 1829 to 1981 and 2007 to 2134 (up to 2438 wide) & 1930 to 2134 (from 4204 to 4648 wide)

Note 7'6"-8'0" (2286mm - 2438mm) wide Frensham doors have extra wide end stiles - please ask for details before ordering. The feature height of single doors up to 6'6" (1981mm) high, over 6'7" (2007mm) high and the double doors all vary, please check for doors to be fitted side by side.



# ONE PIECE UP & OVER GARAGE DOORS

NEW  
4 CROWN  
"FLOWCOAT"  
BACK

WIDTH	GOTHIC					MAJESTIC					PEMBROKE (WIDE GRAIN)				
	CANOPY		RETRACTABLE			CANOPY		RETRACTABLE			CANOPY		RETRACTABLE		
	3	4	3	4	5	3	4	3	4	5	3	4	3	4	5
1981mm (6'6")	2190	2310	2237	2357	2878	1336	1456	1383	1503						
2134mm (7'0")	2190	2310	2237	2357	2878	1336	1456	1383	1503		1362	1482	1409	1529	1947
2261mm (7'5")	2485	2605	2532	2652	3173	1373	1493	1420	1540		1568	1688	1615	1735	2153
2286mm (7'6")	2485	2605	2532	2652	3173	1373	1493	1420	1540		1568	1688	1615	1735	2153
2438mm (8'0")	2535	2655	2582	2702	3223	1424	1544	1471	1591		1619	1739	1666	1786	2205
2743mm (9'0")			2885	3085									1918	2118	2589
3048mm (10'0")			3126	3326									2086	2286	2757
3353mm (11'0")			3264	3464									2287	2487	
3658mm (12'0")			3457	3657									2556	2756	
3962mm (13'0")			3641	3841									2644	2844	
4267mm (14'0")			3665	3865									2670	2870	
4572mm (15'0")			4090	4290									3056	3256	
4877mm (16'0")			4582	4782									*3360	*3560	
MtoM widths: 5'0" to 16'0" MtoM heights: 6'4" to 7'0"					SS widths: 6'6", 7'0", 7'5", 7'6", 8'0" SS heights: 6'6" or 7'0"					MtoM widths: 6'10" to *15'6" MtoM heights: 6'3" to 7'0"					
MtoM widths (mm): 1524 to 4877 MtoM heights (mm): 1930 to 2134					SS widths (mm): 1981, 2134, 2261, 2286, 2438 SS heights (mm): 1981 or 2134					MtoM widths (mm): 2083 to *4724 MtoM heights (mm): 1905 to 2134					

WIDTH	PEMBROKE TALL (WIDE GRAIN)					PURBECK					SHERBOURNE				
	CANOPY		RETRACTABLE			CANOPY		RETRACTABLE			CANOPY		RETRACTABLE		
	3	4	3	4	5	3	4	3	4	5	3	4	3	4	5
1981mm (6'6")															
2134mm (7'0")			1526	1646		1607	1727	1654	1774	2193	1362	1482	1409	1529	1947
2261mm (7'5")			*1734	*1854		1655	1775	1702	1822	2240	1568	1688	1615	1735	2153
2286mm (7'6")			1734	1854		1655	1775	1702	1822	2240	1568	1688	1615	1735	2153
2438mm (8'0")			1785	1905		1705	1825	1752	1872	2291	1619	1739	1666	1786	2205
2743mm (9'0")			*2017	*2217				*1844	*2044	*2516			1918	2118	2589
3048mm (10'0")			*2187	*2387									*2086	*2286	*2757
3353mm (11'0")			2388	2588											
3658mm (12'0")			*2655	*2855									*2556	*2756	
3962mm (13'0")			2745	2945									2644	2844	
4267mm (14'0")			*2770	*2970				*2704	*2904				2618	2818	
4572mm (15'0")			3156	3356				3036	3236				3056	3256	
4877mm (16'0")			*3460	*3660											
MtoM widths: 6'10" to *8'7", *9'2" to 11'0", *11'6" to *13'4", 14'0" to *15'9" MtoM heights: 7'0" to 8'0"					MtoM widths: 6'10" to *8'4" & *13'6" to 15'0" MtoM heights: 6'2" to 7'0"					MtoM widths: 6'73/4" to 9'4" & *11'3" to 13'0" & 13'41/2" to 15'0" MtoM heights: 6'6" to 7'0"					
MtoM widths (mm): 2083 to *2616, *2794 to 3353, *3505 to *4064 & 4267 to *4801 MtoM heights (mm): 2134 to 2438					MtoM widths: 2083 to *2540 & *4115 to 4572 MtoM heights: 1880 to 2134					MtoM widths (mm): 2026 to 2845 & *3429 to 3962 & *4078 to 4572 MtoM heights (mm): 1981 to 2134					

# ONE PIECE UP & OVER GARAGE DOORS

NEW  
4 CROWN  
"FLOWCOAT"  
BACK

8

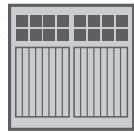

WIDTH	SHERWOOD (WIDE GRAIN)				
	CANOPY		RETRACTABLE		
	3	4	3	4	5
1981mm (6'6")					
2134mm (7'0")	1607	1727	1654	1774	2193
2261mm (7'5")	*1655	*1775	*1702	*1822	*2240
2286mm (7'6")	1655	1775	1702	1822	2240
2438mm (8'0")	1705	1825	1752	1872	2291
2743mm (9'0")			*1844	*1964	*2516
3048mm (10'0")					
3353mm (11'0")					
3658mm (12'0")					
3962mm (13'0")					
4267mm (14'0")			2704	2904	
4572mm (15'0")			3036	3236	
4877mm (16'0")			3334	3534	

MtoM widths: \*7'0" & \*7'2" to \*8'6"  
& \*13'11" to 16'0"  
MtoM heights: 6'4" to 7'0"

MtoM widths (mm): \*2134 & \*2184 to \*2591 & \*4242 to 4877  
MtoM heights (mm): 1930 to 2134

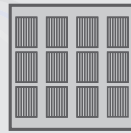

WIDTH	TUDOR				
	CANOPY		RETRACTABLE		
	3	4	3	4	5
2033	2153	2081	2201	2620	
2033	2153	2081	2201	2620	
2329	2449	2376	2496	2916	
2329	2449	2376	2496	2916	
2382	2502	2428	2548	2969	
		2620	2820	3290	
		2861	3061	3531	
		2999	3199		
		3190	3390		
		3375	3575		
		3400	3600		
		3839	4039		
		4331	4531		

MtoM widths: 5'0" to 16'0"  
MtoM heights: 6'4" to 7'0"

MtoM widths (mm): 1524 to 4877  
MtoM heights (mm): 1930 to 2134

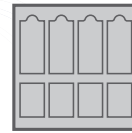

WIDTH	WARWICK				
	CANOPY		RETRACTABLE		
	3	4	3	4	5
1362	1482	1409	1529	1947	
1362	1482	1409	1529	1947	
1568	1688	1615	1735	2153	
1568	1688	1615	1735	2153	
1619	1739	1666	1786	2205	
		1918	2118	2589	
		2086	2286	2757	
		2287	2487		
		2556	2756		
		2644	2844		
		2670	2870		
		3056	3256		
		3360	3560		

MtoM widths: 6'6" to 16'0"  
MtoM heights: 6'6" to 7'0"

MtoM widths (mm): 1981 to 4877  
MtoM heights (mm): 1981 to 2134

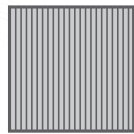

WIDTH	YORK				
	CANOPY		RETRACTABLE		
	3	4	3	4	5
1362	1482	1409	1529	1957	
1362	1482	1409	1529	1947	
1568	1688	1615	1735	2153	
1568	1688	1615	1735	2153	
1619	1739	1666	1786	2205	
		1918	2118	2589	
		2086	2286	2757	
		2287	2487		
		2556	2756		
		2644	2844		
		2670	2870		
		3056	3256		
		3360	3560		

MtoM widths: 5'0" to 16'0"  
\*\*MtoM heights: 5'10" to 8'0"

MtoM widths (mm): 1524 to 4877  
\*\*MtoM heights (mm): 1778 to 2438

\*\*York - Minimum heights 5'10" (1778mm) on canopy gear, 6'0" (1829mm) on single size retractable gear, 6'1" (1854mm) on Double or Heavy retractable gear.

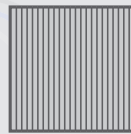

WIDTH	HAXBY (WIDE GRAIN)				
	CANOPY		RETRACTABLE		
	3	4	3	4	5
1362	1482	1409	1529	1957	
1362	1482	1409	1529	1947	
1568	1688	1615	1735	2153	
1568	1688	1615	1735	2153	
1619	1739	1666	1786	2205	
		1918	2118	2589	
		2086	2286	2757	
		2287	2487		
		2556	2756		
		2644	2844		
		2670	2870		
		3056	3256		
		*3360	*3560		

MtoM widths: 5'0" to \*15'6"  
MtoM heights: 5'10" to 7'6"

MtoM widths (mm): 1524 to \*4724  
\*\*MtoM heights (mm): 1778 to 2286

NEW



All prices exclude VAT and delivery



# OPTIONS & AUTOMATION

## WINDOW, LOCK, COLOUR, DRAUGHT STRIP AND BRACKETS

Black windows on single doors up to 2438mm (8'0") wide (please specify leading requirements)		160 per door
Black windows on double doors over 2438mm (8'0") wide (please specify leading requirements)		320 per door
Clear or Stippled windows on single doors up to 2438mm (8'0") (please specify leading requirements)		328 per door
Clear or Stippled windows on double doors over 2438mm (8'0") (please specify leading requirements)		655 per door
Clear or Stippled windows on single doors up to 2438mm (8'0") (please specify leading requirements)		360 per door
Clear or Stippled windows on double doors over 2438mm (8'0") (please specify leading requirements)		720 per door
Clear or Stippled windows on single doors up to 2438mm (8'0") (please specify leading requirements)		430 per door
Clear or Stippled windows on double doors over 2438mm (8'0") (please specify leading requirements)		860 per door
Colour Option available for Woodgrain doors only – blue, green and red for single doors up to 2438mm (8'0") wide		300 per door
Colour Option available for Woodgrain doors only – blue, green and red for double doors over 2438mm (8'0") wide		395 per door
Brass effect finish lock (upgrade from black lock)		45 per set
Adjustable deep reveal brackets (for use with retractable gear only) Size 1	0 - 152mm (0" - 6")	58 per pair
	Size 2 152 - 305mm (6" - 12")	63 per pair
	Size 3 305 - 457mm (12" - 18")	65 per pair
	Size 4 457 - 610mm (18" - 24")	67 per pair
Draught Strip (bottom edge brush strip helps prevent dirt and draughts blowing into your garage) single/double doors		42 / 81

9

## FRAMES

### Steel Frames

#### Canopy Doors

Suitable for all single doors up to 2438mm x 2134mm (8'0" x 7'0"). Frames are pre-fitted to the door. Standard frame jambs are 54mm (2.1/8") wide (optional jambs of 68mm (2.2/3") available on request) and head is 68mm (2.2/3") high. Minimum door height 1778mm (5'10").

#### Single Retractable Doors

Suitable for all single doors up to 2438mm x 2286mm (8'0" x 7'6") except 5 crown up to 2286mm x 2134mm (7'6" x 7'0"). Frames are pre-fitted to the door. Jambs are 68mm (2.2/3") wide and head is 68mm (2.2/3") high. Minimum door height 1829mm (6'0").

#### Double Retractable Doors on Double or Heavy Door Gear

Suitable for all double doors on double or heavy gear up to 4877mm x 2438mm (16'0" x 8'0"). Frames are supplied separate and NOT pre-fitted to doors. Jambs are 68mm (2.2/3") wide and head is 68mm (2.2/3") high. Minimum door height 1854mm (6'1").

#### UPVC Timber Cored Frame Sections

Supplied in three sections with mitred corners, these frames are 70mm x 70mm (2.3/4" x 2.3/4") for doors up to 4877mm x 2438mm (16'0" wide x 8'0" high). Frames include a fixing groove and cover strip for concealed fixing. Frames are available in White or Woodgrain laminate finish in Rosewood and Golden Oak (closely matches G.R.P. Dark Mahogany and Honey Beech colour finishes). Frame sections are not pre-fitted and are supplied loose for fitment to any door.

#### UPVC Timber Cored Uprights Only (per pair)

Uprights are available in 70mm x 70mm (2.3/4" x 2.3/4") for doors up to 2438mm (8'0") high. Uprights are available in finishes as uPVC frame sections above. Uprights are not pre-fitted and are supplied loose for fitment to any door.

#### G.R.P. Frame Sections

Supplied in three sections, these frames are in two sizes 70mm x 70mm or 95mm x 70mm (2.3/4" x 2.3/4" or 3.3/4" x 2.3/4") for doors up to 4877mm x 2438mm (16'0" wide x 8'0" high). Frames are available in Gloss White or Woodgrain finish in standard colours. Frame sections are not pre-fitted and are supplied loose for fitment to any door.

Steel Frames (Standard Sizes or Made to Measure)	Low maintenance white, brown or black / Woodgrain *** Golden oak or Rosewood
54mm to suit Canopy doors gear pre-fitted to doors	127/150
68mm to suit Canopy and Retractable doors with gear pre-fitted to doors	144/170
To suit Retractable doors, Double door gear supplied loose NOT pre-fitted to doors	348/370

\*\*\*Woodgrain Golden Oak and Rosewood are polymer laminates and provide a reasonable match to Honey Beech and Dark Mahogany respectively. Please request a sample for confirmation.

UPVC Timber Cored Frames c/w fixing groove & cover strip	White	Textured Grained Black, Woodgrain Rosewood or Golden Oak (closely matches G.R.P. Dark Mahogany & Honey Beech)
Width	Height	
Up to 8ft (2438mm)	Up to 8ft (2438mm)	151 199
Up to 11ft (3353mm)	Up to 8ft (2438mm)	190 237
Up to 16ft (4877mm)	Up to 8ft (2438mm)	237 308
Jambs only	Up to 8ft (2438mm)	131 172

G.R.P. Frames (3 section)	Up to 2134mm (7'0")	2134mm (7'0") - 3353mm (11'0")	3353mm (11'0") - 4572mm (15'0")	4572mm (15'0") - 4877mm (16'0")
Gloss White 70mm x 70mm	363	426	485	568
Gloss White 95mm x 70mm	409	501	551	634
Woodgrain 70mm x 70mm	392	457	521	605
Woodgrain 95mm x 70mm	448	520	592	683







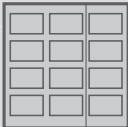

## ELECTRIC OPERATORS

Electric Operators & Boom Options	
DC-700 (For retractable doors)	370
DC-850 (For retractable doors)	450
Kevlar belt drive	48
Chain drive	0
Medium extended toothed belt / chain drive boom	21
Medium extended toothed Kevlar belt drive boom	74
Long extended chain drive boom (DC-850)	53
Long extended Kevlar belt drive boom (DC-850)	95

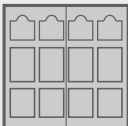
Operator Accessories DC-700/850	
Beam break	70
Beam Break Bracket	15
Wireless bell push	40
Wired bell push	12
Electric key switch control	41
Exterior digital keyless entry pad	93
Emergency release (handle type)	31
External receiver	102
Car cigarette lighter transmitter (3 channel)	58
Mini transmitter (4 channel)	49
Three function wired wall control	37
Impulse socket receiver	72

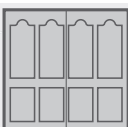
# SIDE HINGED GARAGE DOORS

10

STYLE	CLASSIC	PREMIER	DOOR LEAF	SIZE & WINDOW AVAILABILITY
 CHELTENHAM GLOSS WHITE	1201	1525	2/3 : 1/3	Widths 2007mm - 2438mm (6'7" - 8'0") Heights 1880mm - 2134mm (6'2" - 7'0") M-M 
 EDWARDIAN GLOSS WHITE	1201	1525	2/3 : 1/3	Widths 2007mm - 2438mm (6'7" - 8'0") Heights 1880mm - 2134mm (6'2" - 7'0") M-M 
 EMSWORTH- GLOSS WHITE	1201	1525	50 : 50	Widths 2007mm - 2438mm (6'7" - 8'0") Heights 1905mm - 2286mm (6'3" - 7'6") M-M  7+
 GRAFTON GLOSS WHITE	1201	1585	50 : 50	Widths 2083mm - 2438mm (6'10" - 8'0") Heights 1905mm - 2286mm (6'3" - 7'6") M-M  7+
 NEWBURY GLOSS WHITE	1201	1525	50 : 50	Widths 1981mm - 2438mm (6'6" - 8'0") Heights 1880mm - 2134mm (6'2" - 7'0") M-M
 BOSTON WOODGRAIN	1299	1585	2/3 : 1/3	Widths 1778mm - 2286mm (5'10" - 7'6") Heights 2134mm - 2438mm (7'0" - 8'0") M-M  7+
 FRENSHAM WOODGRAIN	1299	1585	50 : 50	Widths 2007mm - 2438mm (6'7" - 8'0") Heights 1727mm - 2134mm (5'8" - 7'0") M-M

Key:  Made to measure  Windows available  Heights over 2134mm available

## OPTIONS

Locking	£
Eurolock multi-point latch upgrade to standard Classic range night latch	150
Brass effect hinge upgrade to Classic range	43
Left hand opening / Inward opening - only available on doors with Euro-style locking and supplied without stays	59 / 102

WINDOWS	£
*Black windows - Cheltenham, Boston, Edwardian, Emsworth, Grafton, Majestic, Rushmoor, Sherborne	160
*Clear or stippled windows - Cheltenham, Boston, Edwardian, Emsworth, Grafton, Majestic, Rushmoor, Sherborne / Sherwood	328 / 430

\*Available with border, diamond or square leading - please state when ordering

Frames	£
50/65mm white, black or brown frame	Standard / 25
50/65mm Golden Oak or Rosewood laminate frame#	38 / 38
Unframed (deletion cost)	-43

Frame colours are; White, Brown, Black



#Woodgrain Golden Oak and Rosewood are polymer laminates and provide a good match to Honey Beech and Dark Mahogany respectively. Please request a sample for confirmation.

Colours	£
Red / green / blue solid woodgrain colour option	300

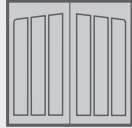
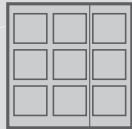
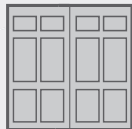

All prices exclude VAT and delivery

# SIDE HINGED GARAGE DOORS

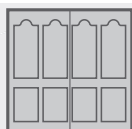
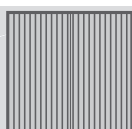
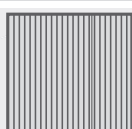
STYLE	CLASSIC	PREMIER	DOOR LEAF	SIZE & WINDOW AVAILABILITY
 LOXWOOD WOODGRAIN	1299	1643	50 : 50	Widths 2083mm - 2438mm (6'10" - 8'0") Heights 1905mm - 2286mm (6'3" - 7'6") M-M 7+
 MAJESTIC WOODGRAIN	1231	1585	2/3 : 1/3	Widths 1981mm - 2438mm (6'6" - 8'0") Heights 1854mm - 2134mm (6'1" - 7'0") M-M ☒
 RUSHMOOR WOODGRAIN	1390	1643	50 : 50	Widths 2083mm - 2438mm (6'10" - 8'0") Heights 1905mm - 2286mm (6'3" - 7'6") M-M ☒ 7+
 SHERWOOD WOODGRAIN	1398	1702	50 : 50	Widths 2134mm - 2438mm (7'0"* - 8'0") Heights 1905mm - 2134mm (6'3" - 7'0") M-M ☒
 WARWICK WOODGRAIN	1390	1585	50 : 50	Widths 1981mm - 2438mm (6'6" - 8'0") Heights 1880mm - 2134mm (6'2" - 7'0") M-M
 YORK WOODGRAIN	1122	1585	50 : 50	Widths 1219mm - 2438mm (4'0" - 8'0") Heights 1778mm - 2286mm (5'10" - 7'6") M-M 7+
 YORK WOODGRAIN	1122	1585	2/3 : 1/3	Widths 1524mm - 2438mm (5'0" - 8'0") Heights 1778mm - 2286mm (5'10" - 7'6") M-M 7+

Key:  Made to measure  Windows available  Heights over 2134mm available

11

## TECHNICAL & GENERAL INFORMATION

### Classic

- Choice of 50mm (standard) or 65mm (optional) Frame\*
- 3/4 steel hinges per side (dependent on size)
- Silver effect nightlatch with white lock body, single point latching
- Bonded steel chassis for strength
- Pair of white polyester painted stays
- Two shoot bolts (inactive leaf)
- Draft strip to all 3 sides
- Bottom weather strip
- Outward opening, right hand leading leaf viewed from outside (Left hand leading or inward opening available - see options right)

### Premier

- Choice of 50mm (standard) or 65mm (optional) Frame\*
- 3/4 brass effect dog bolt hinges per side (dependent on size)
- Brass Eurocylinder nightlatch with double throw deadbolt and multi-point latching
- The rear of the door is reinforced with a steel chassis that is covered with a "flowcoat" of resin for increased rigidity and a neat, light reflecting finish
- Pair of white painted stays
- Two shoot bolts (inactive leaf)
- Draft strip to 3 sides
- Bottom weather strip
- Outward opening, right hand leading leaf viewed from outside (Left hand leading or inward opening available - see options right)

\* 65mm frame has 65mm uprights and a 68mm head

\* 50mm frame has 50mm uprights and a 38mm head

### General Information

- **Handle Positions**  
These will vary between doors of different sizes of the same style.
- **Glazed G.R.P. Doors**  
All window design doors are fitted with standard black (opaque) windows, which cannot be seen through. Clear and stippled translucent windows are available as options.
- **Matching Woodgrain G.R.P. Doors**  
Where doors are to be fitted in close proximity and are required to be coloured as closely as possible, it is vital that they are clearly requested 'To Match' at time of ordering.
- **Made to Measure Door Prices**  
There is no additional charge for made to measure sizes. Note: please refer to the size parameter details beside the price for the actual minimum / maximum door size available.
- **Opening Size**  
All door sizes stated in this price list refer to internal frame dimensions. Due to the bespoke nature of Wessex garage doors we regret we can not accept order cancellations.
- **Top & Bottom Rails & End Stiles**  
Top, bottom, centre and end stiles (edges) may vary in width or height between doors of the same style depending on size ordered. This is to enable us to cater for your particular size of garage door. If in doubt, please refer to Wessex before ordering.
- **Translucency**  
Translucency of the door panel on Classic doors may vary when viewed from the inside on a bright day due to variations in laminate thickness. This does not represent a manufacturing defect and overall performance is not affected.

**VIENNA, OSLO & VERONA**

A double skinned fully finished and made to measure G.R.P. Sectional Garage door. The panels are made from triple layer resin 450 gram CSM glass mat reinforcement and 'matted in' steel stiffeners. The rear of the door is finished with a white flat back panel. Doors over 4420mm (14'6") have additional white powder coat bracings attached to the rear of the panels. Doors features full weather seals on both sides, at the head and where the door closes to the ground to reduce water and wind borne debris ingress. The interface of each panel has an anti finger-trap CEN compliant safety design (patent pending). Available in High Gloss White (Vienna only) and all standard Wessex Woodgrain colours including the three solid colour options.

**VIENNA, OSLO & VERONA DC MODEL**

The DC model has all the benefits of the standard door but is supplied with a state-of-the-art electric operator which is matched to the door. A DC700, with a 700N lifting force, is supplied for doors up to 3048mm (10'0") wide and the more powerful DC850, with 850N lifting force, is supplied for doors over this size. Both operators feature DC motors, soft start-soft stop and anti-back drive security system. This reacts to movement on the boom, if forced entry of a closed door is attempted, and automatically switches from stand-by mode to drive the door closed. A quiet chain drive one-piece boom is standard with a kevlar belt drive option available as a cost option for even smoother, quieter operation. Please note that an extended boom is recommended for doors over 2134mm (7'0") high.

**VIENNA, OSLO & VERONA "40" MODEL**

The "40" model has double skinned, foam filled, insulated panels for maximum insulation, sound proofing and strength. The rear of the door is finished with a white flat back panel. Doors over 4420mm (14'6") have additional white powder coat bracings attached to the rear of the panels. The "40" model also has all round weather seals and an anti finger-trap panel interface design (patent pending). Available in High Gloss White (Vienna only) and all standard Wessex Woodgrain colours including the three solid colour options.

**VIENNA 40 DC**

The "40" DC model has all the benefits of Standard "40" model but is supplied with a state-of-the-art electric operator which is matched to the door. A DC700, with a 700N lifting force, is supplied for doors up to 3048mm (10'0") wide and the more powerful DC850, with 850N lifting force, is supplied for doors over this size. Both operators feature DC motors, soft start-soft stop and anti-back drive security system. This reacts to movement on the boom, if forced entry of a closed door is attempted, and automatically switches from stand-by mode to drive the door closed. A quiet chain drive one-piece boom is standard with a kevlar belt drive option available as a cost option for even smoother, quieter operation. Please note that an extended boom is recommended for doors over 2134mm (7'0") high.

**GEARING**

Lifting gear is a CEN Compliant galvanised steel dual track system with standard low head room gear. It requires only 70mm side and headroom clearance and the top edge of the top panel does not rise above the horizontal track. If the 'Manual locking' option is selected, headroom requirement increases by 60mm and both DC variants require an additional 30mm headroom for the operator boom (50mm on doors over 4420mm / 14'6"). The spring assembly is not wider than the track which means easy installation to flush walls. There is no reduction of drive through width and drive through height is reduced by only 70mm on a manual door and 30mm on an automated door.

**GENERAL information**

**Locking**

All door variants are supplied without locking. If ordered as a manually operated door, or locking is required, the 'Manual locking' option must be ordered. The door is prepared for the handle to fit in the first right hand vertical stile, viewed from outside, on the second panel up from the floor.

**Window Options**

Vienna, Vienna 40 and DC variants are available with black (opaque) windows, which cannot be seen through. Clear and stippled translucent windows are not available. The Oslo is available with porthole windows to one or all panels. Porthole windows are finished with stainless steel and have a double glazed toughened glass vision panel. Porthole window position is set to 400 mm from the left or right edge of the doors and are installed centrally in the panel profile. Other positions can be accommodated on request.

**Matching Woodgrain Doors**

Where doors are to be fitted in close proximity and are required to be coloured as closely as possible, it is vital that they are clearly requested 'To Match' at time of ordering.

**Made to Measure Doors**

For a made to measure price take the next door size up e.g. 3810mm (12'6") wide x 2032mm (6'8") high is taken from the 3962mm (13'0") wide x 2134mm (7'0") high price.

**Opening Size**

All door sizes in this price list refer to internal brickwork / internal frame dimensions. See note "How to order your Door"

**How to Order Your Door**

Sectional doors are designed to be fitted either on to the back face of a brickwork opening or on to the back face of a timber frame\* fitted within the opening. Therefore when ordering your door you must either give us the internal brickwork opening size for doors being fitted directly to the back of the brickwork, or the internal timber frame\* size for doors being fitted on to a timber frame\*.

\*Timber frame must be a minimum of 70mm x 70mm (23/4" x 23/4").

**Top & Bottom Rails & End Stiles**

Top, bottom and end stiles (edges) may vary in width or height between doors of the same style depending on size ordered. This is to enable us to cater for your particular size of garage door. If in doubt, please refer to Wessex before ordering.

**Finishing & maintenance**

G.R.P. Doors

Please study the cleaning and maintenance label attached to the back of the door for advice on keeping your door in top class condition.

**Door Lubrication**

All doors require regular (6 monthly) lubrication of the pivot points and bearings. Full details are contained in the Wessex Service Passport supplied with the door.

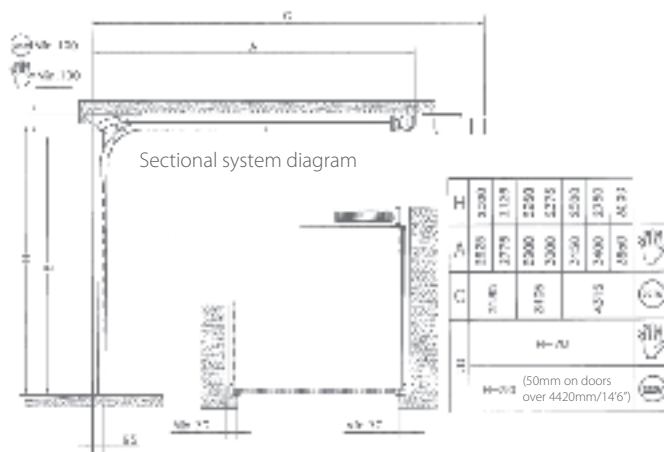

**G.R.P. CROWN RANGE****• 3 Crown G.R.P. Doors**

Garage doors in standard and made to measure sizes, with an integral steel frame bonded over to provide added strength and rigidity. Available with canopy or retractable gear.

**• 4 Crown G.R.P. Doors**

Garage doors in standard and made to measure sizes, Featuring an integral steel frame is bonded over then covered with a "flowcoat" of resin for increased rigidity and a neat interior finish in light reflecting white. Available with canopy or retractable gear.

**• 5 Crown G.R.P. Doors**

Garage doors in standard and made to measure sizes, with an integral steel frame with a flat back G.R.P. panel bonded to the back of the door. This provides supreme rigidity and an attractive backing to hide the bracing normally visible on all other G.R.P. doors. Available with retractable gear only. Due to the double-wall construction of these doors, no clear or stippled window options are available. NB. 5 Crown doors are only available up to a maximum of 3048mm (10'0") wide and a maximum of 2134mm (7'0") high.

**GEARING****• Canopy Gear**

Canopy doors between 1778mm (5'10") and 2134mm (7'0") high and up to 2438mm (8'0") wide are fitted with Canopy gear featuring high security three point locking and five point retention.

**• Single Retractable Gear**

All retractable doors (excluding 5 Crown) between 1829mm (6'0") and 2286mm (7'6") high and up to 2438mm (8'0") wide and all 5 Crown doors up to 2286mm (7'6") wide and 2134mm (7'0") high are supplied with cranked gear. This gear includes unique maximum opening width feature and multi springing. Three point locking is standard on most doors.

**• Double and Heavy Retractable Gear**

All doors over 2286mm (7'6") high, all 5 Crown doors over 2286mm (7'6") wide and all other doors over 2438mm (8'0") wide are supplied with these gears. All have multi-springing feature.

**LOCKING**

All Wessex doors are supplied with secure multi-point locking as standard. Optional brass effect lock available.

**GENERAL INFORMATION****• Handle Positions**

These will vary between canopy and retractable doors of the same size and same style, and between doors of different sizes of the same style with the same gear.

**• Handle Holes**

These will be drilled as standard. If a handle hole is not required this must be clearly stated at time of ordering.

**• Glazed G.R.P. Doors**

All window design doors are fitted with standard black (opaque) windows, which cannot be seen through. Clear and stippled translucent windows are available as options on 3 Crown doors only.

**• Matching Woodgrain G.R.P. Doors**

Where doors are to be fitted in close proximity and are required to be coloured as closely as possible, it is vital that they are clearly requested 'To Match' at time of ordering.

**• Made to Measure Door Prices**

Take the next door size up e.g. 3810mm (12'6") wide x 2032mm (6'8") high take the 3962mm (13'0") price. Note: Where a price is marked \* please refer to the size parameter details below the price for the actual maximum / minimum door size available.

**• Opening Size**

All door sizes stated in this price list refer to internal frame dimensions. Due to the bespoke nature of Wessex garage doors we regret we can not accept order cancellations.

**• Top & Bottom Rails & End Stiles**

Top, bottom and end stiles (edges) may vary in width or height between doors of the same style depending on size ordered. This is to enable us to cater for your particular size of garage door. If in doubt, please refer to Wessex before ordering.

**FINISHING & MAINTENANCE****• G.R.P. Doors**

Please study the cleaning and maintenance label attached to the back of the door for advice on keeping your door in top class condition.

**• Steel Frames**

Primed steel frames require a suitable undercoat and topcoat to be applied shortly after delivery in order that the product warranty is not invalidated.

**• Door Lubrication**

All doors require regular (6 monthly) lubrication of the pivot points and bearings. Full details are contained in the Wessex Service Passport supplied with the door.

## TECHNICAL &amp; GENERAL INFORMATION

## AUTOMATION

Feature	DC - 700	DC - 850
Door suitability	Retractable and sectional	Retractable and sectional
Opening force	700N peak force electronic "Soft Start and Stop"	850N peak force electronic "Soft Start and Stop"
Normal running load	200W max (with 230V, 40 Watt light on)	250W max (with 230V, 40 Watt light on)
"Stand-by" load	<4 Watts (energy saving circuit)	<4 Watts (energy saving circuit)
Motor	24V DC with thermal overload protection on transformer	24V DC with thermal overload protection on transformer
Chipset	Smart Entry System auto-calibrating motherboard with Numerical Display diagnostics	Smart Entry System auto-calibrating motherboard with Numerical Display diagnostics
Drive method	Chain (Kevlar Belt Option)	Chain (Kevlar Belt Option)
Safety door reverse	To fully open position / Part reverse option in advanced settings	To fully open position / Part reverse option in advanced settings
Light	Integral 240V fitting with diffuser cover. 40W maximum	Integral 240V fitting with diffuser cover. 40W maximum
Standard boom	1 piece 'C' channel with 2590mm carriage travel – total operator length 3353mm	1 piece 'C' channel with 2590mm carriage travel – total operator length 3353mm
Extended boom (optional) Medium	1 piece assembled C-channel with 2840mm carriage travel	1 piece assembled C-channel with 2840mm carriage travel
Extended boom (optional) Long	N/A	1 piece assembled C-channel with 3600mm carriage travel
Door size suitability	For Wessex doors up to 4267 x 2286mm (14'0" x 7'6") or 3658 x 2438mm (12'0" x 8'0") except 5 Crown doors up to 3048 x 2134mm (10'0" x 7'0")	For all Wessex retractable and sectional doors including those outside the range of the DC - 700
Headroom required	30mm	30mm
Sideroom required	None	None
Manual disconnect	Yes	Yes
Radio receiver	Digital module. Easy to exchange for other frequencies	Digital module. Easy to exchange for other frequencies
Radio transmitter	2 digital 868MHz four button mini handsets, with multibit coding (281 billion variations)	2 digital 868MHz four button mini handsets, with multibit coding (281 billion variations)
Transmitter range	10 – 50 metres	10 – 50 metres

### Canopy Door Gear Specification

14

#### STANDARD DOOR AND BRICKWORK APERTURE SIZES

canopy gear should be fitted either to a weatherbeaded 70mm x 70mm (2 3/4" x 2 3/4") standard timber 'goalpost' frame (not supplied) or a Wessex steel frame (standard frame dimensions = 54mm (2 1/8") wide on side section (optional 68mm (2 2/3") available on request) 68mm (2 2/3") high on top section, 35mm (1 1/3") deep all round).

The minimum headroom required above the lower face of the frame head is 48mm (1.7/8").

#### NOTES

- In use the lifting gear reduces drive through heights by 91 mm (3 5/8"), although there is no reduction in width.
- For back fixed frames allow the frame to overlap into the aperture by 13mm (1/2") on both sides to allow for coursing and tolerances.

#### FITTING FRAMES TO THE BRICKWORK

Frames may be fitted within or behind the brickwork as per the drawings shown. Fitting behind the brickwork, if the garage length allows, will increase the drive-through width.

A weatherbead should always be fitted to the under-side of the door frame lintel in front of the door to hide the top gap. This feature is integral on the Wessex steel frame.

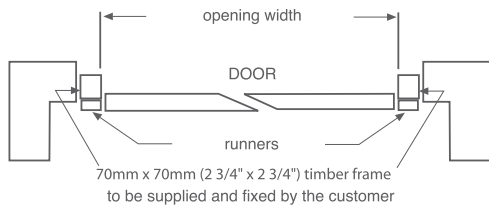

Fitting to timber frame, within the brickwork aperture.

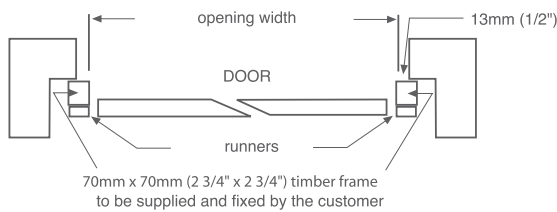

Fitting to timber frame, behind the brickwork aperture.

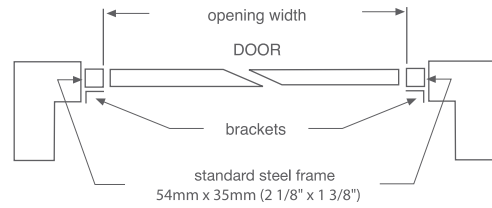

Fitting to Wessex standard steel canopy frame, within the brickwork aperture.

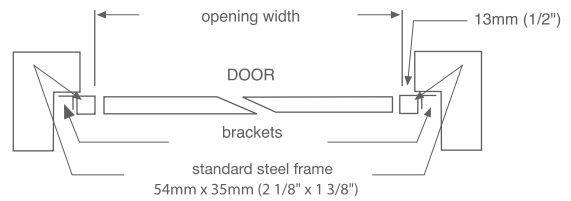

Fitting to Wessex standard steel canopy frame, behind the brickwork aperture.

#### Opening arcs of travel

1981mm (6'6") high canopy doors

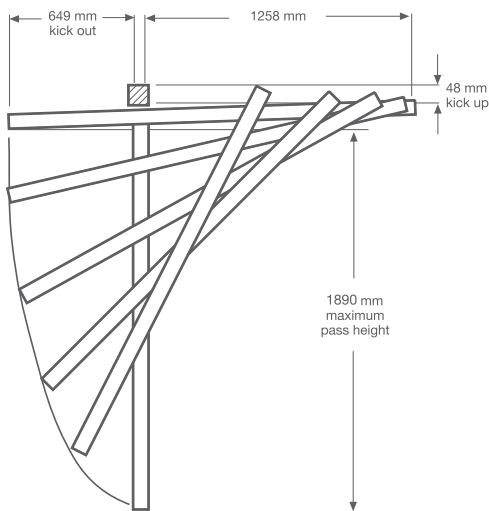

2134mm (7'0") high canopy doors

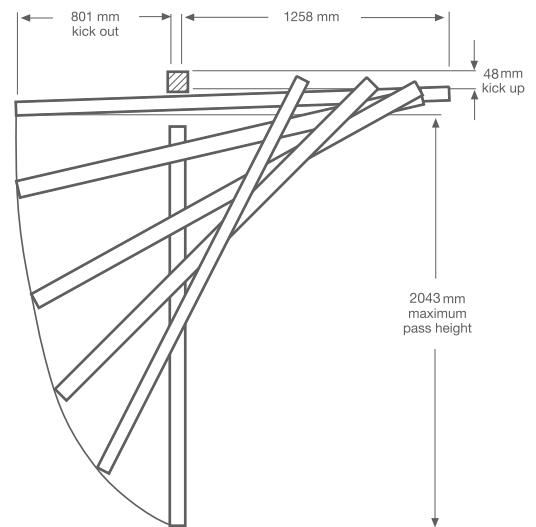

ALL OTHER DOOR SPECIFICATIONS For further information, please ask for details.



## Retractable Door Gear Specification

### All DOORS

Supplied with Single, Double or Heavy gear depending on size, see page 13.

- Wessex retractable door gear should be fitted to a weatherbeaded 70mm x 70mm (2 3/4" x 2 3/4") standard timber 'goalpost' frame (not supplied). Alternatively single gear may be fitted to a Wessex quick-fit steel retractable frame (dimensions = 68mm (2 2/3") wide by 60mm (2 1/2") deep all round).
- Doors supplied with double or heavy gear can also be supplied with an optional steel frame kit not pre-fitted to the door. Dimensions: 68mm (2 2/3") wide x 75mm (3") deep.

### NOTES

- In use, lifting gear reduces drive through width by up to 130mm (5.1/4") see below. With single retractable gear there is no reduction in drive-through width up to 1048mm (3'5. 1/4") from the ground on 1981mm (6'6") high doors (1200mm (3'11.1/4") on 2134mm (7'0") high doors).
- If drive-through clearances are critical, please ask for full details.

### FITTING FRAMES TO THE BRICKWORK

Frames may be fitted within or behind the brickwork as per the drawings shown. Fitting behind the brickwork, if the garage length allows, will increase drive-through width by up to 114mm (4.1/2").

A 20mm x 20mm (4/5" x 4/5") weatherbead should be fitted to the underside of the door frame lintel in front of the door. This feature is integral on the Wessex steel frame.

Fitting to timber frame, within the brickwork aperture.

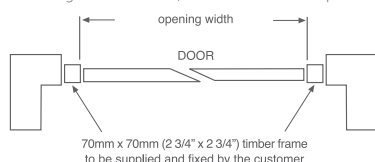

Fitting to timber frame, behind the brickwork aperture.

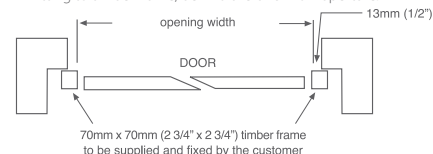

Fitting to Wessex steel retractable frame, within the brickwork aperture.

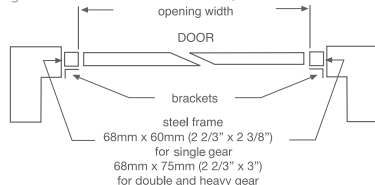

Fitting to Wessex steel retractable frame, behind the brickwork aperture.

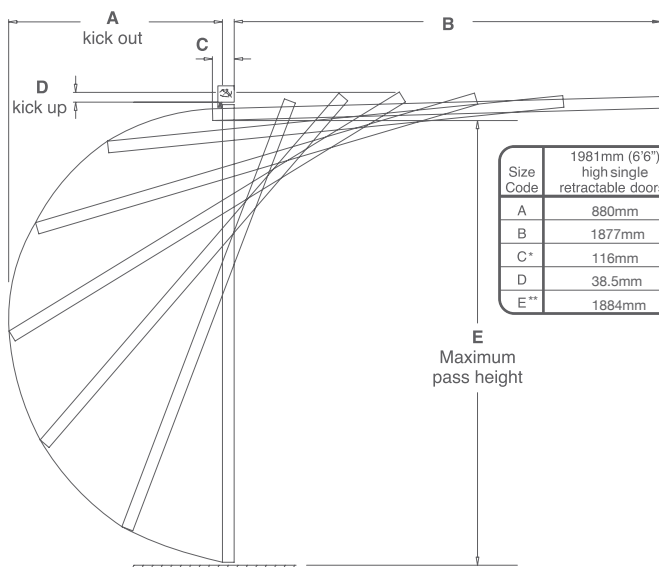
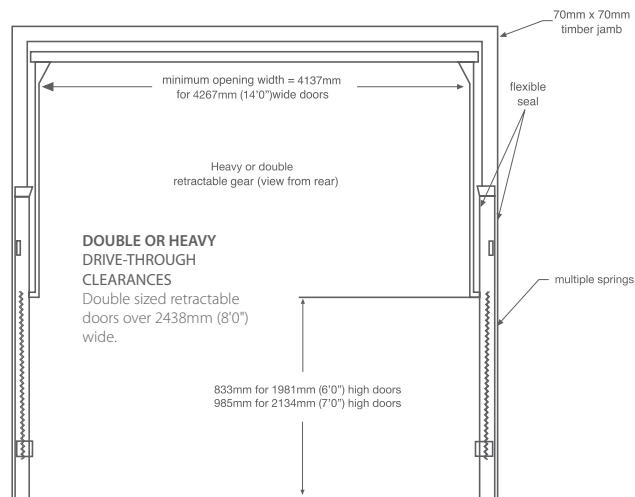
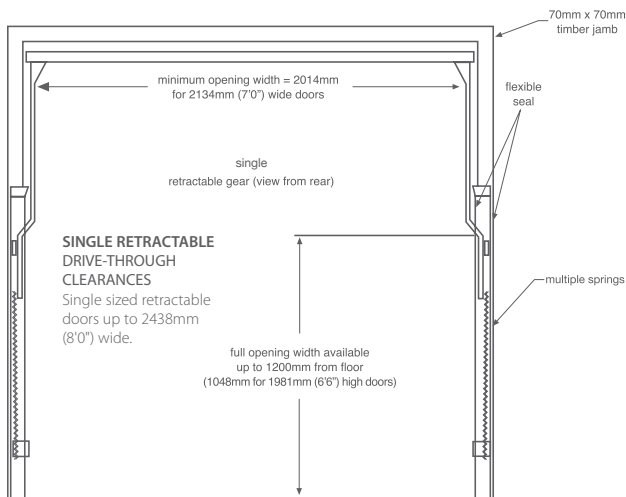
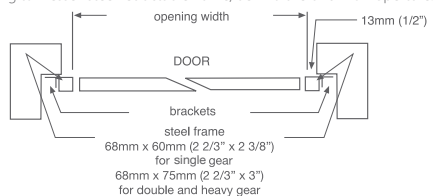

Size Code	1981mm (6'6") high single retractable doors	2134mm (7'0") high single retractable doors
A	880mm	1030mm
B	1877mm	1877mm
C*	116mm	268mm
D	38.5mm	38.5mm
E**	1884mm	2030mm

Size Code	1981mm (6'6") high double retractable doors	2134mm (7'0") high double retractable doors
A	900mm	1040mm
B	1877mm	1877mm
C*	131mm	283mm
D	43mm	43mm
E**	1890mm	2040mm

\*C The amount that the door protrudes out from the back face of the frame with the door in the open position

\*\*E

Note: For doors over 2134mm (7'0") tall - if drive through is critical please check dimension prior to ordering

CI/SfB			
127	(31.56)	X	

Date: 1st May 2011 Issue 2

Please Note:

- As Wessex GRP Products' policy is one of continuous improvement, we reserve the right to change the specification or withdraw any products without prior notice.
- All details are correct at time of going to press. E & OE.

Product Guarantee – WESSEX GRP PRODUCTS LIMITED. (Wessex)

Subject to conditions set out below;

- Wessex garage doors are guaranteed against any form of manufacturing defect for a period of 2 years from the date of original purchase.
- Wessex electric operators are guaranteed against any form of manufacturing defect for a period of 2 years for mechanical elements, motors and transformers and for a period of 2 years for other electronic and radio equipment.
- The Exterior finish is guaranteed to provide an effective weatherproof membrane which will resist perforation of the substrate from the weather side due to corrosion for the periods indicated below.  
2 years - GRP
- Colour change or fade to the exterior surface will be limited and uniform for a period of 2 years.

## CONDITIONS

- During the comprehensive 2 year guarantee period Wessex GRP Products Limited undertake to repair or replace (at its discretion), and without charge, products or components which have suffered any form of manufacturing defect. Claims must be notified within 3 days from the date of delivery or within a reasonable time after discovery of any defect.
- Products covered by these guarantees must have been purchased through an authorised Wessex garage door distributor or as original equipment attached to a newly built dwelling.
- The warranties shall apply for normal use only. Normal use constitutes no more than 5 operations (open/close cycles) per day.
- The warranties offered attach to the Wessex product only and no consequential damages will apply no matter how caused.
- No liability will be accepted as a result of normal wear and tear, incorrect storage, incorrect handling, faulty installation, incorrect use, non adherence to routine maintenance schedule or wilful damage..
- Claims under this guarantee must be made through the original supplier and accompanied by relevant documentation indicating the date of purchase (e.g. receipt).
- Wessex GRP Products Limited maximum liability shall be the original purchase price inclusive of Value Added Tax at the rate prevailing when supplied.
- Any product which is the subject of a claim:
  - must have been correctly installed in accordance with the installation instructions supplied and thereafter properly maintained by a suitably experienced engineer on a regular basis as set out in the Maintenance and Operating Instructions provided with every door. (Additional copies of these instructions are available by calling 01942 832 355). We recommend that regular maintenance is provided by a suitably experienced engineer. See your Yellow Pages for your local Wessex Garage Door or AGDS specialist.
  - must have the manufacturers reference number still intact (found on the barcode label on the door)
  - must not have been modified in any way.
- Claims will not be accepted where the cause is due to:
  - impact or mechanical damage suffered during or following installation, e.g. scratches, indentations, tears, scuffs or other surface abrasion.
  - damage or discolouration caused by contact with any form of caustic, abrasive or corrosive substance, fumes, bird droppings, fire, smoke, floodwater, salts, acids, or from exposure to abnormal atmospheric pollution.
- This guarantee excludes normal wear and tear on items such as cones, cables, spindles, lock cylinders, hinges or springs.

- Only Wessex original spare parts must be used when required. The use of non-Wessex parts shall invalidate this guarantee. Warranty period for replacement parts is 6 months or the balance of the original warranty period if greater.
- The Exterior Finish Guarantee applies only to the weatherside surface and where more than 5% of the surface area of the door is affected. Surfaces must be freely exposed to washing by rainfall and kept clear of accumulated dirt and debris and given equal exposure to local environmental conditions and consistent natural lighting conditions across the face of the door. Special attention is drawn to Clause (9) (i).
- The guarantee period for electric operators excludes batteries, fuses and light bulbs.
- Parts replaced free of charge become the property of Wessex GRP Products Limited.
- Attempted repairs by non-qualified individuals shall invalidate this guarantee.
- The specific terms of this guarantee shall only apply to products purchased on or after August 2010 within the UK and Eire.
- Wessex garage doors and associated products are sold subject to the Wessex GRP Products Limited Standard Terms and Conditions of Sale, copies of which are available upon request. Wessex GRP Products Limited shall not be liable as a result of any representation, implied warranty or other term or condition or for any consequential loss or damage, costs, expenses or other claims whatsoever except as expressly set out in these Terms and Conditions of Sale.

## General Advice

## Door Cleaning

Periodically clean the door panel using warm water and a soft cloth or sponge. Allow to dry naturally. Never use detergent, abrasive, caustic or solvent based cleaners as they may damage the door surface. Bird droppings should be removed immediately as these can be particularly caustic.

## Customer Maintenance

Moving parts should be lubricated regularly to ensure smooth operation. Every six months visually inspect all wear items (including cables) for signs of wear. If wear is detected we recommend you contact your local Wessex approved service engineer to arrange for a replacement. Garage door springs are under extreme tension and should only be repaired or replaced by a suitably qualified engineer.

## Other performance issues affecting Wessex. garage doors are:

Wessex G.R.P. doors are individually handcrafted products manufactured to specific customer order. Due to the nature of the product and the hand finishing processes used they may occasionally display small blemishes which do not detract from the overall appearance of the product. These are regarded as being within manufacturers tolerance when such blemishes are not visible to the naked eye when viewed from a distance of three metres. Similarly, Woodgrain effect products will, like the natural material, display colour variations across their surface and colour will vary from door to door. Ordering doors to match helps reduce the variation but will not eradicate it entirely.

Translucency of the door panel may vary when viewed from the inside on a bright day due to variations in laminate thickness. This does not represent a manufacturing defect and overall performance is not affected.

Size and Deflection - the natural curing process does not affect the ultimate product size and a tolerance of  $\pm 6$ mm on both height and width is deemed acceptable. One piece up and over doors in the 'open' position will display a level of vertical deflection or 'sag' across the width of the panel and up to 6mm per linear metre is within design tolerance.

These terms and conditions do not affect your statutory rights.

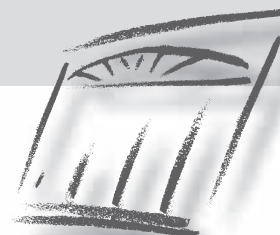

**wessex**  
DOORS